

Powerful. Beautiful.

# Excellence · Innovation

IDD4X215L-5K



21.5" FHD Economical Industrial Arm-Mounted Operation Panel



## Features

- Display type: 21.5"
- Front panel/back cover: All aluminum housing
- Front panel/Rear cover: IP65 / IP20
- Screen Type: Single point resistive touchscreen, Multi-point capacitive touchscreen, Non-touch screen
- OS: Win7, Win8, Win10, Win11, Linux, etc
- Interface: DVI, HDMI, VGA video interface, 2xUSB
- DC 12~36V
- R1(IDD-LINK), Long distance USB signal output, support 50m
- R2(IDD-LINK4), Video and USB are transmitted via a single CAT6 network cable, Transmission distance up to 100m

## Namely Rule

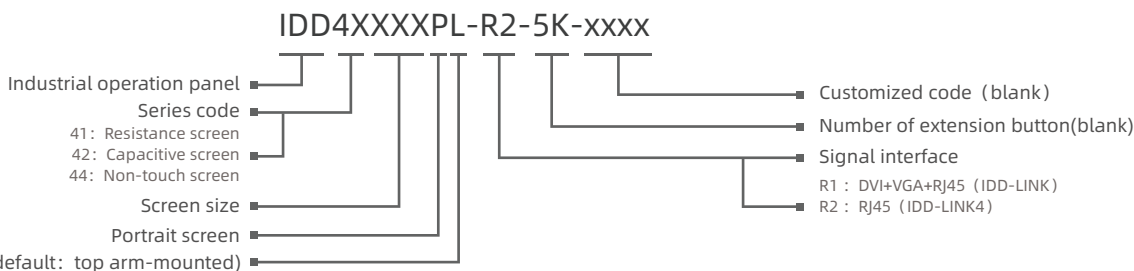

## Specifications

Model	IDD41215L-5K&IDD42215L-5K&IDD44215L-5K	
Routine	Control button	Set contrast ratio and luminance via OSD at the back cover
	Housing	Front panel & back cover: Aluminium-magnesium alloy, Grounding isolation protection
	Mounted	4460 or 48 arm-mounted
	Display Port	VGA & DVI & HDMI & USB
Power	Input Voltage	Phoenix terminal: DC 12~36V input
	Power	20W
Physical	Dimension (WxHxD)	(without keyboard bracket) 517.6mm x 379mm x 129mm (20.38" x 14.92" x 5.08")
	Net Weight(kg)	(without keyboard bracket) 8kg
LCD	Display Type	21.5" FHD TFT
	Resolution	1920 x 1080
	Colors	16.7M
	Active Area (WxH/mm)	476.64mm x 268.11mm (18.77" x 10.56")
	Backlight	LED
	MTBF (hour)	30000hrs
	Pixel Pitch (HxV)	0.24825 x 0.24825
	Luminance(cd/m2)	250cd/m2
	Contrast Ratio	3000:1
	Viewing Angle	(L)89 / (R)89 / (U)89 / (D)89
Touchscreen	Touch Type	Single point resistive touchscreen & Multi-point capacitive touchscreen & Non-touch screen
	Light Transmission	>85%
	Controller	USB interface
	Driver Support	Windows7, Window8, Windows10, Windows11, Linux, etc
	Multi-touch	10 points
	Surface Hardness	Resistive touchscreen: Mohs' Number >= 3H; Capacitive touchscreen: Mohs' Number 7H
Environment	Operating Temperature	0 ~ 50°C
	Storage Temperature	-20 ~ 60°C
	Relative Humidity	5~95% (Non condensation)
	Shock	Operating 10G peak acceleration(11 ms duration), follow IEC 60068-2-27
	Vibration	Operating Random Vibration Test 5~500Hz, 1Grms@with HDD; 2Grms@with SSD, follow IEC 60068-2-64
	EMC	CE/FCC Class A
	Front Panel Protection	Front panel IP65

# IDD4X215L-5K

## Technical Drawings unit: mm

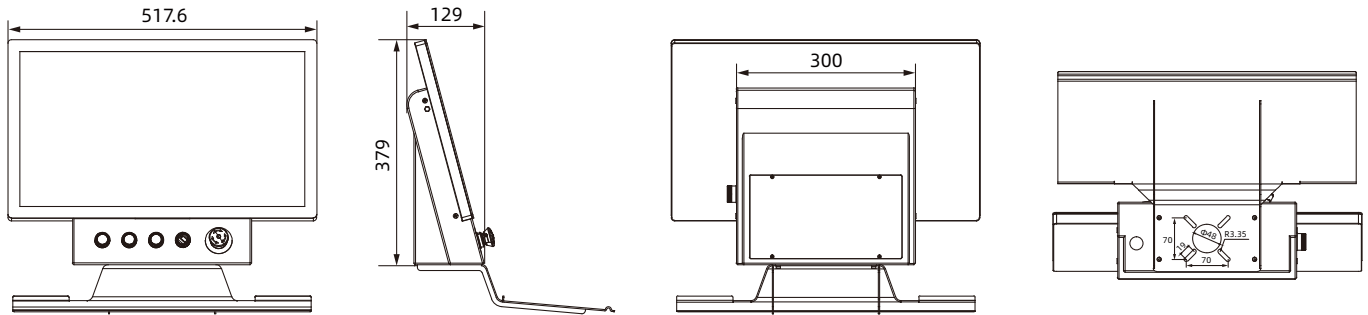

## External I/O View

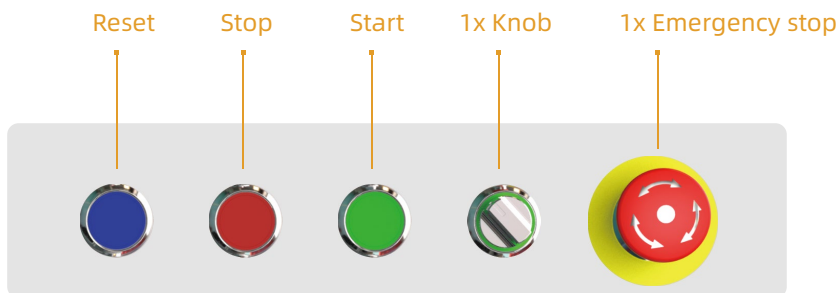
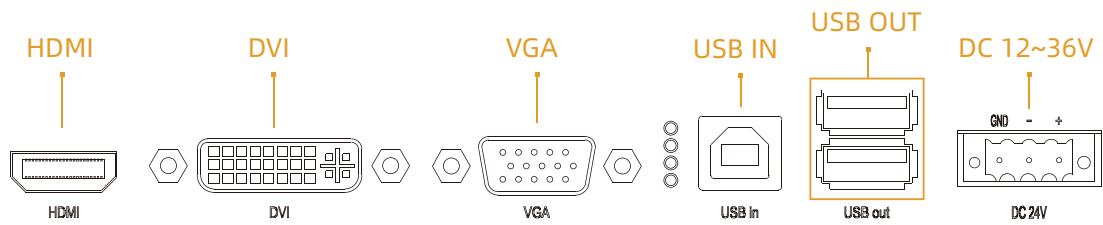

Note: The figure above shows the number of standard buttons  
The number and brand of buttons can be customized

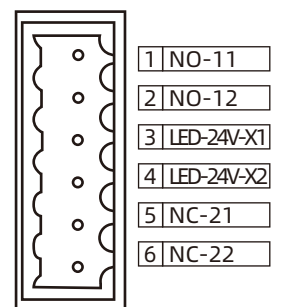
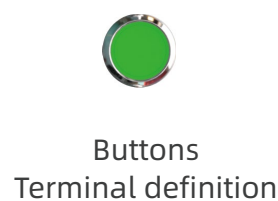
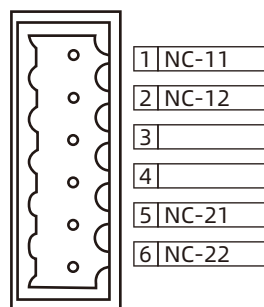
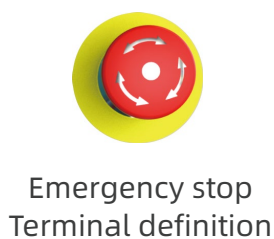

## Ordering Information

Part Number	Description
IDD41215L-5K	21.5" TFT LCD / Resistive touch screen / DC 12~36V Input / Resolution 1920x1080
IDD42215L-5K	21.5" TFT LCD / Capacitive touch screen / DC 12~36V Input / Resolution 1920x1080
IDD44215L-5K	21.5" TFT LCD / Non-touch screen / DC 12~36V Input / Resolution 1920x1080

## Optional Accessories

VGA	VGA 3m / 5m
DVI	DVI 3m / 5m / 8m / 10m
USB	USB 3m / 5m / 10m
HDMI	HDMI 3m / 5m / 10m

## Packing List

Keyboard bracket	1 x Sheet metal keyboard bracket
Terminal	3P connector terminal
Terminal	6P connector terminal

Note: Package contents are subject to change without prior notice

# PANELMATE

Creative HMI Solution



**Panelmate Türkiye Distribütörü**  
**ICC Dijital Endüstriyel Teknolojiler Ltd. Şti.**

 **+90 216 510 6696**

**Osmangazi Mahallesi Atayolu Caddesi No:108 Gate Of Anatolia Ticari Blok Ofis 1**  
**Sancaktepe / İstanbul / Türkiye**